

The logo for ATN, featuring the letters 'ATN' in a bold, black, sans-serif font. The letters are positioned to the left of a large, yellow, downward-pointing triangle that partially overlaps the text.

Automatisierungstechnik
Niemeier GmbH

Automated soldering for solar modules production



!!! New !!!
soldering systems
for module production

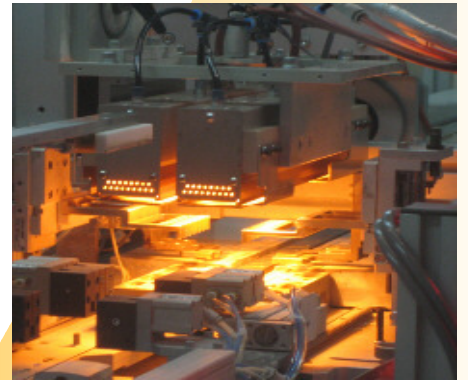

cell contacting

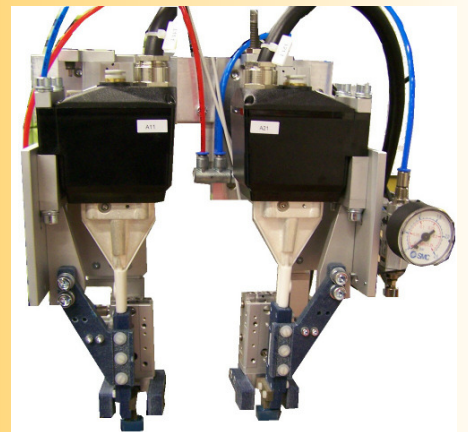

interconnection



J-Box soldering

Soldering systems for module production

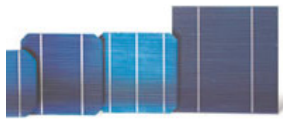

Photovoltaic solar modules make an important contribution to the exploitation of renewable energy.

There are three essential quality-relevant processes in the solar module production:

- contacting the cells with connectors,
- interconnection soldering,
- J-Box soldering.

ATN offers soldering systems in order to realize these processes:

- cost-effective,
- automated,
- with high quality and
- with high process reliability

- 1) halogen line emitter for cell contacting
- 2) induction soldering systems for interconnection
- 3) induction and hot iron soldering for J-Box



J-Box

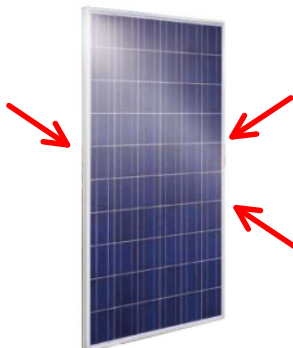

cell contacting



interconnection

LightBeam soldering for cell contacts

IR line emitters

With the LightBeam line emitters ATN offers a wide range of optical systems for contactless heating. The halogen lamp emits light of wavelengths from 500 to 1500nm, using a convergence mirror to focus the IR-light.

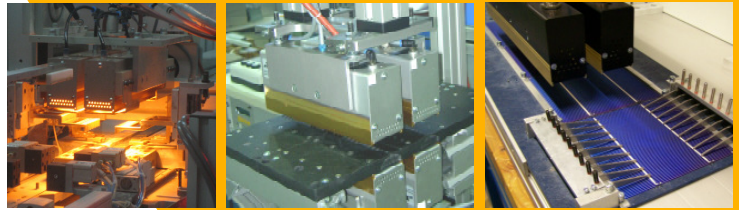

The process time and the emitter power can be set at the menu-driven display in a very convenient way. A ramp function allows the use of temperature profiles. Beam power and process time will be controlled electronically and can be infinitely variable adjusted.

The new LightBeam emitters of ATN allow stress-free soldering even for the thinnest cells.

Manual stringer

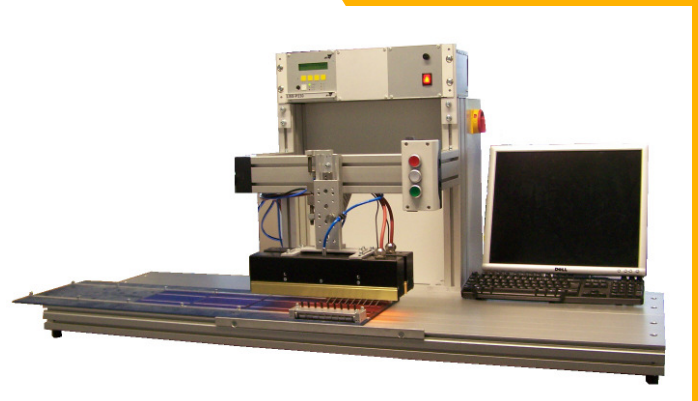

For smaller series the manual stringer machine is a reasonable alternative to the fully automated systems. The operator places the cells and connectors into a soldering frame and fastens the downholder. Thereafter the operator puts the complete string step by step through the soldering station.

To change the cell types only the soldering frame has to be changed. So the production wins a higher flexibility.

ATN Automatisierungstechnik Niemeier GmbH

With the light soldering system LightBeam ATN is a market leader for selective light soldering. The ATN develops, produces and distributes components and software for the manufacturing of electronics, in particular for the automated single point soldering.

ATN was founded in 1996 in the Production Technology Center Berlin (PTZ) and developed 1998 into the ATN Automatisierungstechnik Niemeier GmbH. In the same year ATN moved to the economic and Science Center Adlershof (WISTA) in Berlin. Today ATN has 25 employees.

Our success is based on a customer-oriented work:

For our clients we accomplish soldering attempts and configure systems according to the individual requirements. All technical data and operational sequences are documented, completely illustrated by photos, videos and process investigations and form an important decision basis for our customers.



Induction soldering for interconnection

Robot soldering tools

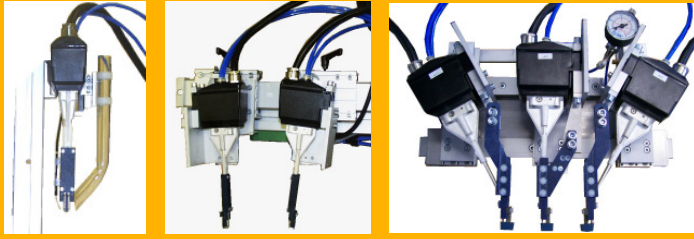

The induction soldering system from ATN (patent pending) heats the soldering joints contactless, as there is a current flow in the inductor. The insulated ceramic stamp puts pressure to the soldering joint until the soldering joint has solidified. Thereby the soldering process will not be influenced by the ceramic stamp. The inductor is free of wearing and contamination because there isn't direct contact between soldering joint and inductor.

Due to standardised interfaces the induction soldering head can be easily integrated into a robot cell. The scalability is realised by using single, double or triple tools.

Automated soldering station

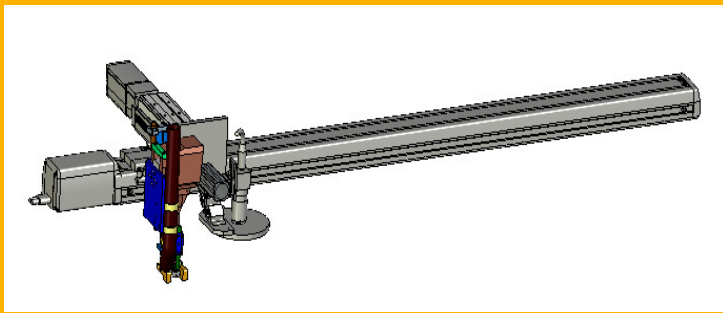

Alternatively to the tools for integration, there is also available a complete soldering station including axes, image processing (for positioning, optional also for solder inspection) and integrated control.

In combination with a manual rotary table it can be used as a semi-automatic system. The operator puts the module into the position and places the cross connectors. The quality-related soldering process runs automatically and therefore reliable and reproducible.



... gives technical support for your special soldering application and recommends you a suitable system from the ATN at optimal costs.

... supports your investment project by application tests with yours construction unit samples, determines optimal process parameters and proposes a soldering process suitable for you!

... automates your manual soldering workshop places, you save time and costs in manufacturing!

... realizes your soldering application reliably, you are able to improve the quality of your products with optimal investment and operating costs of the soldering system!

... can refer to know-how of many years in the soldering technology and to a multiplicity of installed systems in production, research and process evaluation with considerable manufacturers and institutes.

Induction and hot iron soldering of J-Box

Robot soldering tools

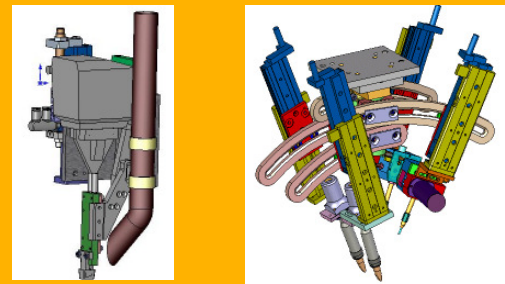

The scalable ATN soldering tools allow the reliable soldering of the J_Box. Depending on the geometry of solder joint the soldering process, induction or hot iron, has to be chosen. Double tools are available for high throughputs.

Soldering station

The manual soldering station enables the reliable and reproducible automation of the soldering process even for smaller quantities.

The operator positions the tool to the J-Box using a manipulator with weight balance. Positioning spikes guarantee the correct position. Then the soldering process runs automatically.

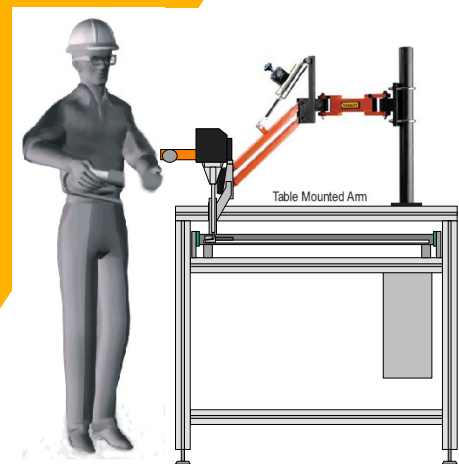

Components and systems for automized single point soldering

Automotive - Electronics - Solar

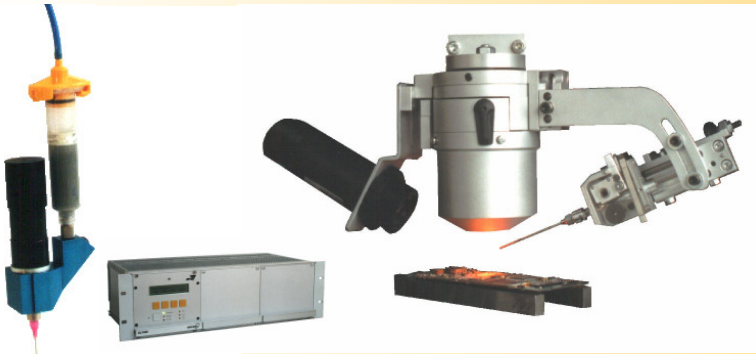

Components

- IR-emitter LightBeam
- solder wire feeder Mosquito
- rotary valve DV747



Standard Machines

- inline-soldering system VARIO
- benchtop machine ECONOMIC



Customer specific Machines

Different kinds from semi-
automated up to fully
automated machines

Your contact:

"ATN as a competent manufacturer of selective soldering systems offers a wide range of standard components and machine platforms, with which automation solutions for the customers can be realised at optimal costs. The user gets individually designed procedure solutions for automation problems around his specific task of soldering."

from:

PLUS PRODUKTION VON LEITERPLATTEN UND SYSTEMEN 11/2002